

PURE DRIVE OCTO

User Guide



Solid State Logic

O X F O R D • E N G L A N D

Visit SSL at:
www.solidstatelogic.com

© Solid State Logic

All rights reserved under International and Pan-American Copyright Conventions.

SSL® and Solid State Logic® are registered trademarks of Solid State Logic.

SuperAnalogue™, VHD™, PureDrive™ and PURE DRIVE OCTO™ trademarks of Solid State Logic.

All other product names and trademarks are the property of their respective owners and are hereby acknowledged.

No part of this publication may be reproduced in any form or by any means, whether mechanical or electronic, without the written permission of Solid State Logic, Begbroke, OX5 1RU, England.

As research and development is a continual process, Solid State Logic reserves the right to change the features and specifications described herein without notice or obligation.

Solid State Logic cannot be held responsible for any loss or damage arising directly or indirectly from any error or omission in this manual.

PLEASE READ ALL INSTRUCTIONS, PAY SPECIAL HEED TO SAFETY WARNINGS.

E&OE

Revision 1.3 - January 2024

Typo corrected - page 23

Table of Contents

Overview	4
Introduction	4
3 Flavours, 1 Mic Pre	4
Analogue Obsession	4
Extensive Connectivity	4
Features	5
Installation	5
Unpacking	5
Rack Mounting, Heat and Ventilation	5
Safety Notices	5
Hardware Overview	6
Front Panel	6
Rear Panel	6
Connections Overview	7
Tutorial	8
Power On	8
Front Panel Controls	8
Power, Digital Clock Setup & Metering	11
Rear Panel Connections	13
USB Audio Interface	15
Aggregate Soundcard (Mac only)	16
Re-purposing the Digital Outputs as DAW Outputs	17
Firmware Updates	18
Settings	19
Settings Layout - Overview Map	19
Autopower On Enable	21
Auto Standby (Sleep) Mode Enable	21
Auto Standby (Sleep) Timeout	21
Button Brightness	20
Meters Brightness	20
Relay Feedback	20
Re-purposing the Digital Outputs as DAW Outputs	22
Safe Mode for Ø, +48V, HPF and LINE Push Functions	23
Peak Hold	23
Meter Release	23
Factory Reset	24
Troubleshooting	25
Specifications	27
Block Diagram	31
Safety Notices	32

Overview

Introduction

PURE DRIVE OCTO takes the highly regarded PureDrive™ mic preamps from the SSL ORIGIN console and delivers them in an 8 channel 2U rackmount device, supercharged with cutting-edge conversion and flexible digital connectivity.

3 Flavours, 1 Mic Pre

Each of the 8 preamps offers a choice of three modes: Clean, Classic Drive and Asymmetric Drive. Clean is a linear, ultra-low noise preamp capable of impeccably recreating the sound source with clarity and detail. Classic Drive introduces pleasing harmonic distortion to enrich the input signal, using predominantly odd harmonics; the same sound signature found on the ORIGIN console. Asymmetric Drive offers up a new colouration option, making the even harmonic content dominant and providing more pronounced thickness, colouration and softening of transients.

Analogue Obsession

PURE DRIVE OCTO continues SSL's obsession for progressive analogue circuit design with high performance mic preamps, evolved from SSL's acclaimed VHD™ (Variable Harmonic Drive)* technology. In addition, PURE DRIVE OCTO features balanced analogue outputs/insert sends for external processing, as well as high headroom insert returns/ADC inputs with +24 dBu A/D line-up level. No electro-mechanical components such as potentiometers, mechanical switches or relays are used in the critical audio signal path which increases product longevity and results in impeccable level matching across all channels. The use of digitally controlled analogue circuits, along with by stepped pots and electronic switches further simplifies recall and precision of settings.

Extensive Connectivity

PURE DRIVE OCTO features extensive connectivity, opening up a world of possibilities; whether you're tracking a band in a world-class recording studio, looking to expand your home studio setup or even going out on tour, PURE DRIVE has you covered with an array of options to best suit your needs. It can also be used to add analogue warmth to stems by running DAW stems through it, using the line-level inputs. Furthermore, an integrated USB audio interface allows you to record directly into your DAW, via cutting-edge 32-bit/192 kHz conversion. Or, use the AES and ADAT outputs to connect to your existing audio interface. The AES and ADAT outputs can also be individually re-purposed to be fed from the on-board USB audio interface (as outputs from your DAW). To round out the digital side of things, there is an auto-ranging word clock input and output for robust digital clocking.

VHD™ (Variable Harmonic Drive) was introduced in the SuperAnalogue™ Duality large-format console in 2006, featuring an innovative FET-based circuit that provides a range of colouration options from 'valve warmth' to 'transistor grit'.

Features

- 8 high performance PureDrive™ mic preamps.
- +48V phantom power, polarity invert and 3rd order hi-pass filter at 75 Hz.
- Stepped Gain control up to +65 dB Gain.
- 31-step Trim control, with precise 1 dB increments.
- 3 modes for each preamp – Clean, Classic Drive and Asymmetric Drive.
- Mic/Line Input Switching - Mic via XLR and Line via choice of TRS Jack or dedicated D-Sub connectivity.
- 4 front panel Hi-Z/DI Instrument inputs with automatic input detection.
- 4 mic preamp input impedance options - 12 k Ω , 1.2k Ω , 600 Ω and 400 Ω .
- Balanced analogue outputs/insert sends for external processing.
- +24 dBu professional line level insert returns/ADC inputs.
- Analogue to digital connectivity via ADAT, AES and USB.
- Ability to switch ADAT and AES connections to source audio from DAW outputs (USB) instead of the A/D converter.
- USB audio interface providing 8 in / 24 out @44.1/48 kHz (8 analogue inputs / 8 AES + 16 ADAT outputs).
- Stepped pots and digitally controlled analogue electronics for precision, stereo matching and ease of recall.
- Up to 192 kHz and 32-bit conversion, professional I/O levels (+24 dBu = 0 dBFS).
- Selectable Auto-Sleep mode.
- Auto-ranging Wordclock In and Out.

Installation

Unpacking

The unit has been carefully packed and inside the box you will find the following items.

- PURE DRIVE OCTO
- IEC power cord for your country
- Safety Sheet

It is always a good idea to save the original box and packaging, just in case you ever need to send the unit in for service.

Rack Mounting, Heat and Ventilation

PURE DRIVE OCTO is a 2U, 19" rackmount piece of equipment designed to sit in the racking of a producer's desk or similar. It is recommended that ventilation space is left above and below the unit so any heat generated by PURE DRIVE OCTO can naturally disperse. The sides of the unit's chassis have cut-outs that should under no circumstances be blocked or covered. Always allow the unit to cool down before handling.

Safety Notices

Please read the safety notice information included on the Safety Sheet inside the box before using PURE DRIVE OCTO. This information is also available in Appendices section of this User Guide.

Hardware Overview

This page provides an overview of the PURE DRIVE OCTO hardware. The tutorial section covers each control in more detail.

Front Panel

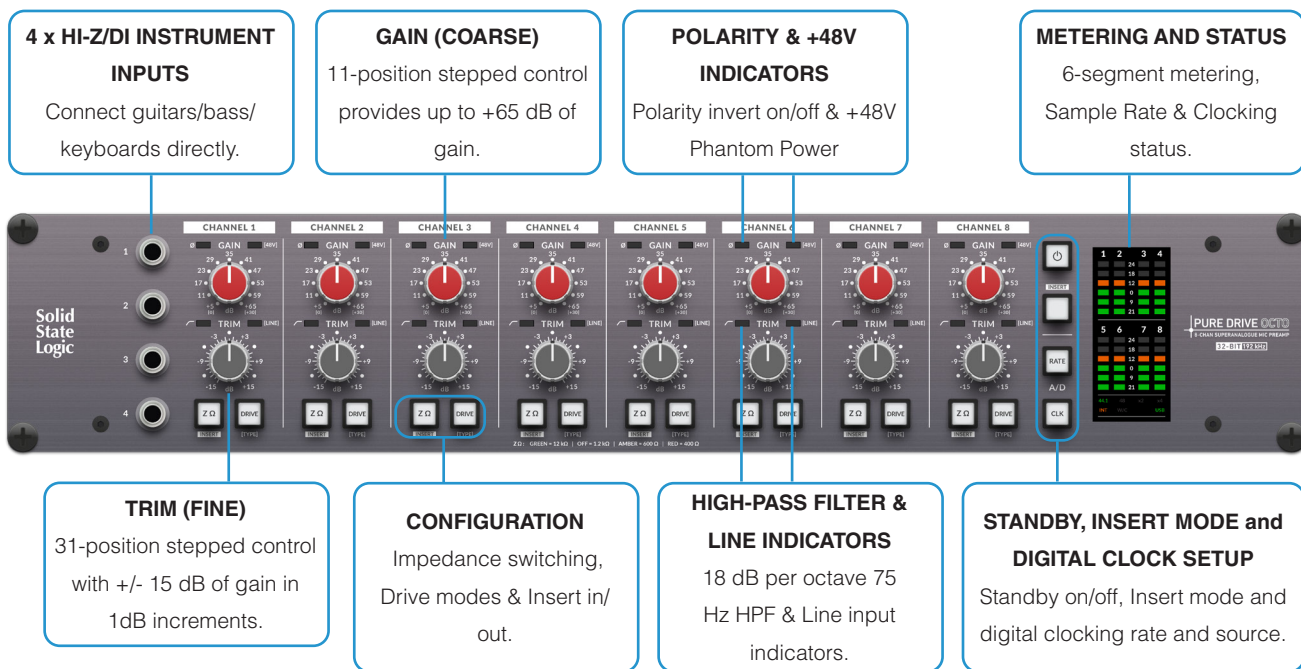

Rear Panel

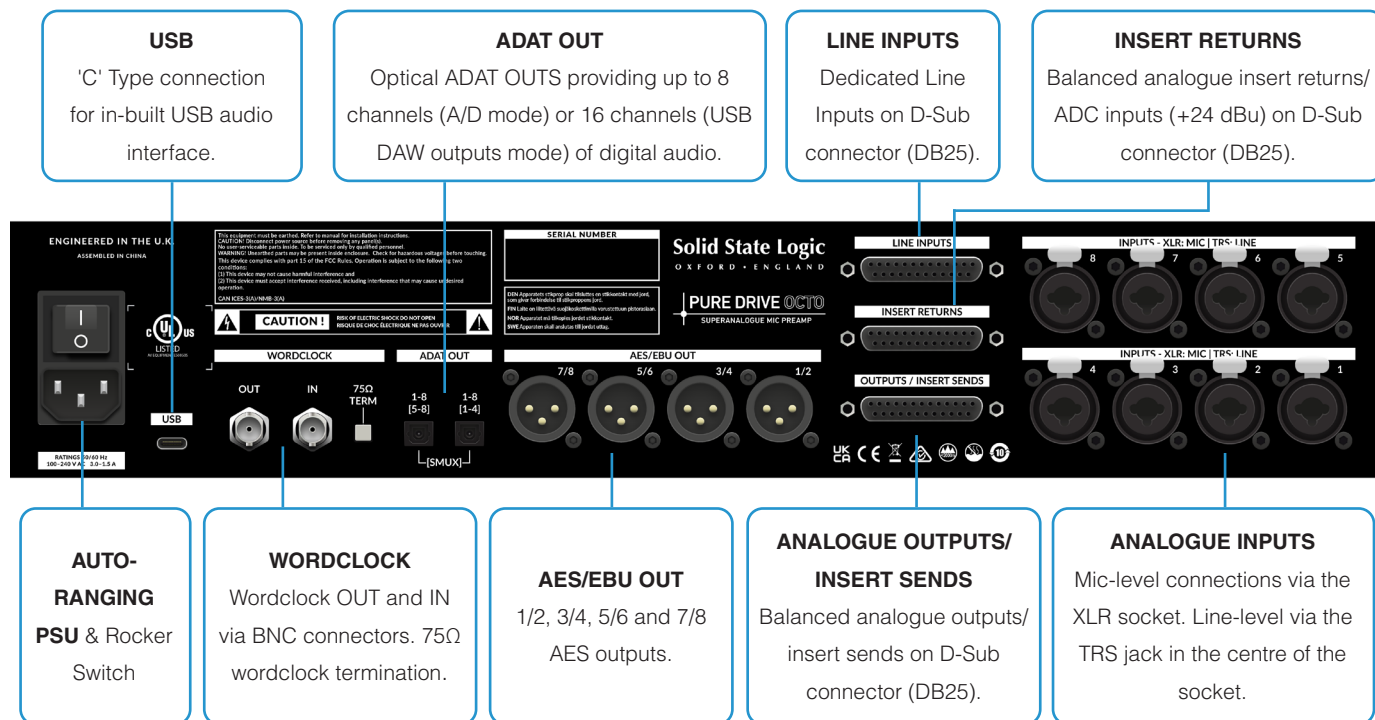

Connections Overview

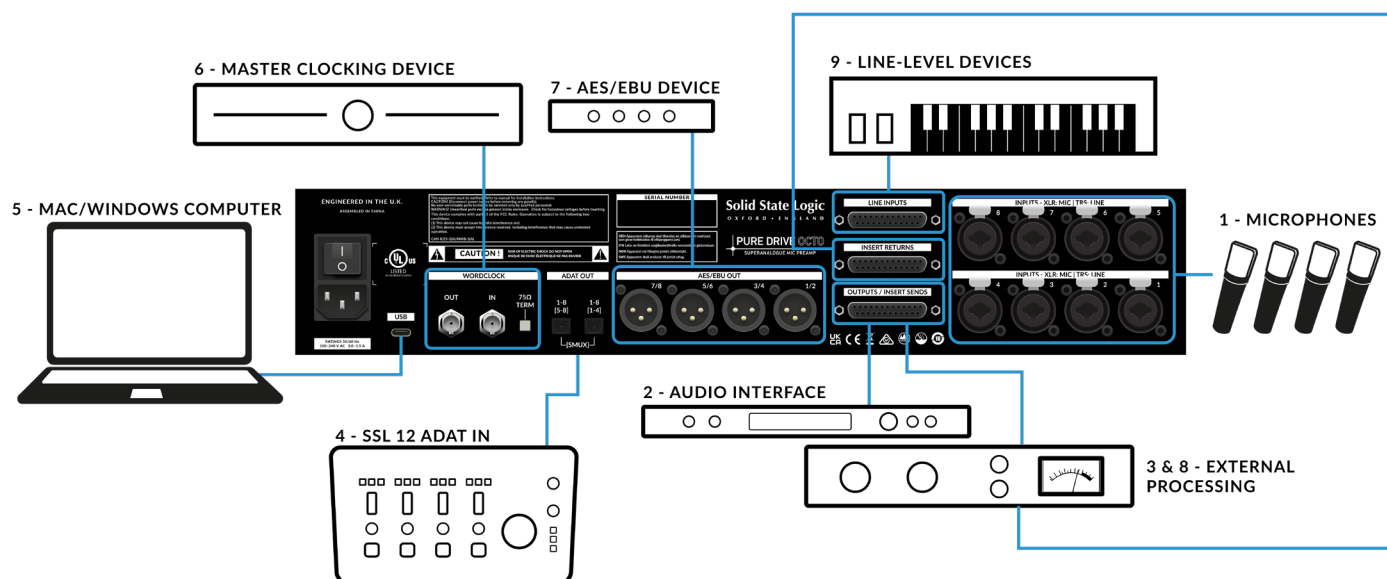

1 - MICROPHONES CONNECTED TO MIC/LINE INPUTS

Connect up to eight microphones using XLR cables to the rear-panel Combo XLR sockets and choose from four impedance options to best suit the loading of each microphone. Or connect line-level sources via the jacks in the centre of the sockets.

2 & 3 - AUDIO INTERFACE & EXTERNAL PROCESSING CONNECTED TO OUTPUTS/INSERT SENDS

Record the analogue outputs of PURE DRIVE into line-level inputs of your audio interface. Alternatively, take the analogue outputs and send them into external processing devices such as outboard compressors.

4 - SSL 12 ADAT IN CONNECTED TO ADAT OUT

Connect PURE DRIVE digitally to an audio interface with an ADAT input, such as SSL 12 to record using the on-board A/D converter.

5 - MAC/WINDOWS COMPUTER CONNECTED TO USB

Connect a USB cable to take advantage of PURE DRIVE's built-in audio interface, allowing you to record directly into your DAW using the on-board A/D converter.

6 - MASTER CLOCKING DEVICE CONNECTED TO WORDLOCK IN

Use the BNC connectors to hook-up PURE DRIVE as part of your digital clocking system.

7 - AES/EBU DEVICE CONNECTED AES/EBU OUT

Use the AES/EBU outputs to conveniently connect to external devices that accept AES/EBU inputs, such as distribution systems and external converters.

8 - EXTERNAL PROCESSING CONNECTED TO INSERTS RETURNS

Return the output from external analogue processors.

9 - LINE-LEVEL DEVICES CONNECTED TO LINE INPUTS

Connect the output of dedicated line-level devices.

Tutorial

Power On

Power on the unit by moving the rear panel rocker-switch into the on position. The start-up sequence will run, concluding with the **+48V** LEDs blinking for a few seconds (if active) as the unit returns to its previous state.

Front Panel Controls

OCTO has 8 channels of preamps, with an identical set of controls for each one.

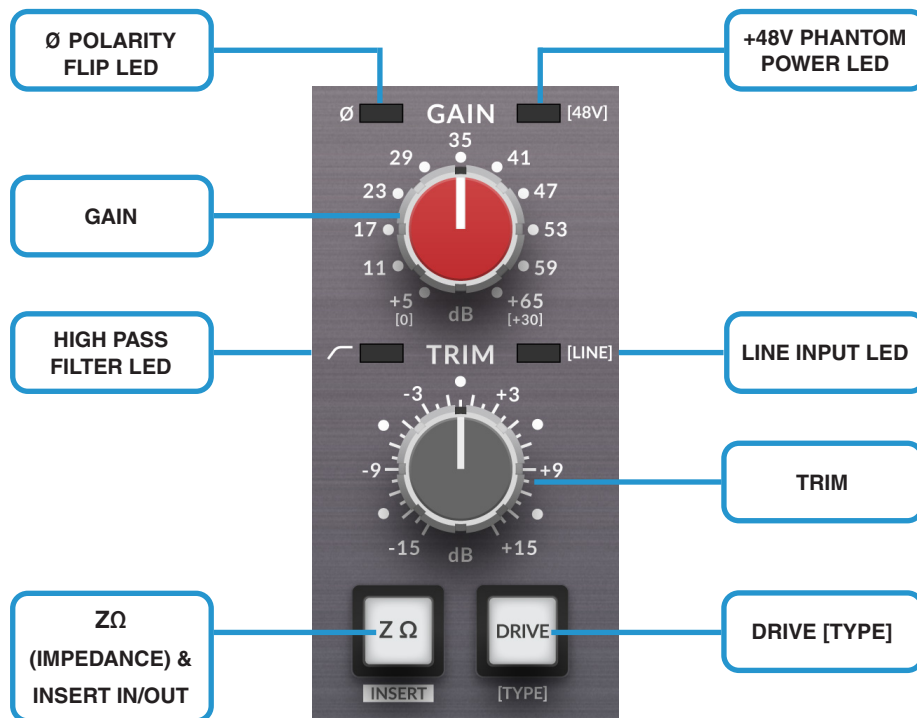

GAIN

11-position stepped control provides +5 to +65 dB of gain for microphone sources (in 6 dB steps) and 0 to +30 dB of gain for Line sources (in 3 dB steps). In Hi-Z mode, the gain range is +11 dB to +41 dB in 3 dB steps.

TRIM

31-position stepped control provides ± 15 dB gain in 1 dB increments. This is a separate gain circuit, post the main **GAIN**.

*Top tip - overdrive the signal with the **GAIN** control and then reduce to a suitable level using **TRIM**, so as not to overload equipment downstream of the preamp or the analogue to digital converter.*

HPF (High-Pass Filter) LED

A 3rd order / 18 dB per octave high-pass filter at 75 Hz can be engaged/disengaged from the signal path by a short press on the **TRIM** control.

POLARITY (Ø LED)

Lights green to indicate the polarity is flipped. To enable/disable polarity flip, push the **GAIN** control. When dealing with multi-mic'd instruments such as drums, phase cancellations can occur due to the microphones receiving the sound waves at different times. Flipping the polarity (or phase as is often referred to) on certain channels can help resolve these cancellations.

Top Tip - It is common practice to flip either the top or bottom snare microphone to ensure a 'fatter' sound.

+48V PHANTOM POWER

A long press on the **GAIN** control provides +48V phantom power (**48V** LED lights red), required for certain condenser and active ribbon microphones. Dynamic or Passive Ribbon microphones do not require phantom power to operate and in some cases can cause damage to the microphone. If in doubt, make sure **+48V** is disabled before plugging in any microphone. When engaging/disengaging **+48V**, the LED will blink for 4 seconds to signify the audio is being temporarily muted in order to avoid any unwanted clicks/pops.

LINE INPUT

A long press on the **TRIM** control switches the input to line mode, which sources the signal from either the rear panel TRS jack or the dedicated D-Sub connector. The connectors are hardwired in parallel so it is recommended to only use one at a time. In **LINE** mode, **+48V** and **ZΩ** functions are disabled and the impedance is fixed at 22kΩ.

ZΩ

Changing the impedance allows you to correctly load match some vintage microphones, or even change the tonality of the input signal, giving further creative control when recording. Press the **ZΩ** button to cycle through input impedance options. Press and hold **ZΩ** to go backwards through the selections. **Green** = 12kΩ, Dim White = 1.2kΩ, **Amber** = 600Ω, **Red** = 400Ω

Generally speaking, for condenser and active microphone altering the microphone impedance will not make a difference to the sound, in which case leaving the preamps set to factory default **Green** (12kΩ) is recommended. For ribbon and dynamic microphones, impedance affects the inherent tone of the individual microphone and therefore can be used as powerful tone shaping tool, almost like an EQ. This works on the principle of the microphone's output impedance as a function of frequency not being constant.

- Selecting a high input impedance will give less deviation from the natural response of the microphone, resulting in a more balanced and natural-sounding frequency response. A general rule of thumb is that the preamp should have an input impedance of at least ten times the output impedance of the microphone.
- A lower input impedance will give a more accentuated response from the microphone, enhancing the timbre and signature of each individual mic. Frequencies at which the microphone's output impedance is higher than average will be attenuated, while frequencies where the microphone's output impedance is lower will be boosted.
- Changing from a high input impedance setting to a low input impedance setting will result in a slight drop in level. This is normal and is a result of the greater ratio between the microphone's output impedance and the preamp's input impedance.

INSERT (Secondary function of the ZΩ button)

The **ZΩ** button on each channel can be hijacked to become enable/disable insert return. To do this, first press the **INSERT** button on the right-hand side of the unit (the one immediately below the **Standby** button). The **ZΩ** buttons will start to pulse. Then press **ZΩ** to enable the insert return on a given channel (green = insert return enabled). To return the **ZΩ** buttons to their normal operation (impedance switching), press the **INSERT** button on the right-hand side of the unit again. Inserts are a great way of incorporating external processing (such as an EQ or compressor) into the signal path ahead of the analogue to digital converter (ADC). Alternatively, you can use the insert return as a way of bypassing the preamp stage, which can be useful when using signal from external preamps or whenever straight-forward, pristine analogue-to-digital conversion is needed.

DRIVE [TYPE]

Toggles between the 3 different microphone preamp modes: Clean, Classic Drive and Asymmetric Drive.

Clean (backlit) - linear, ultra-low noise and distortion preamp capable of impeccably amplifying the sound source with clarity and detail.

Classic Drive (**amber**) - introduces harmonic distortion to enrich the input signal, using predominantly odd harmonics; the same drive sound found on the ORIGIN console. The harmonic distortion is level/gain dependent.

Asymmetric Drive (**green**) - an alternative to Classic Drive mode, where the even harmonic content becomes dominant than the odd harmonics. Results in a more pronounced thickness and softening of transients. The harmonic distortion is level/gain dependent. To engage Asymmetric drive mode press and hold the **DRIVE** button for a second or so.

*Top Tip - The **DRIVE** button flashes red to indicate you are clipping the main preamp or the trim stage. Lower the **GAIN** (or **TRIM**) to correct.*



Classic Drive vs Asymmetric Drive

The graph below shows the difference between the harmonics generated by **Classic Drive** vs **Asymmetric Drive** at a nominal 29 dB of gain.

- The **blue** harmonics are from the **Classic Drive** setting, whereas the **Red** harmonics are from the **Asymmetric Drive** mode.
- Note that the 2nd harmonic is much more prominent in Asymmetric Drive.

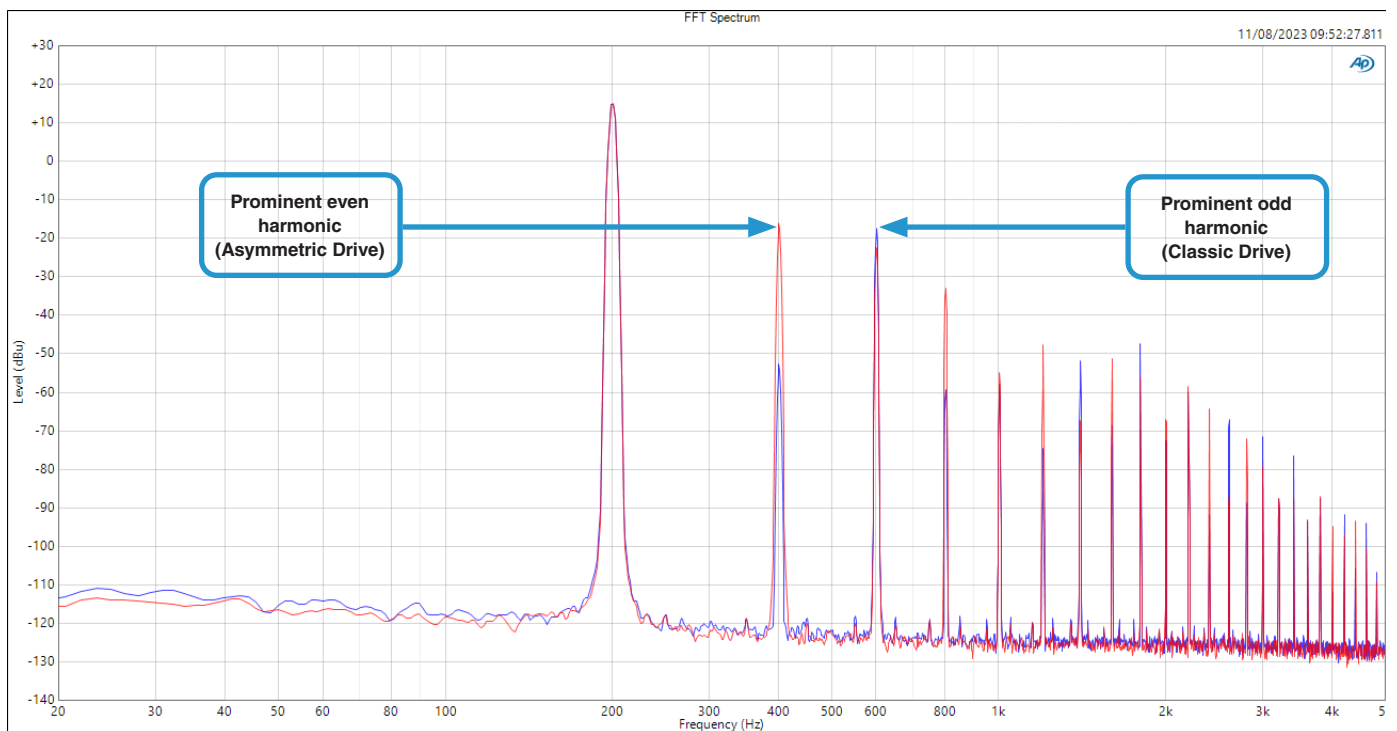

Test tone 200 Hz, 29 dB Gain, input level -14.35 dBu.

Hi-Z/DI - Instrument Inputs

The first four input channels feature a 1MΩ Hi-Z/DI unbalanced Instrument input for connecting sources such as guitars and keyboards.

These inputs have automatic detection meaning that plugging a jack into the socket will automatically cause the Hi-Z/DI Input to be the selected source (instead of Mic or Line). The **+48V**, **LINE** and **ZΩ** buttons are disabled but you can of course still use the **DRIVE** modes to colour the signal (or not) as you please.

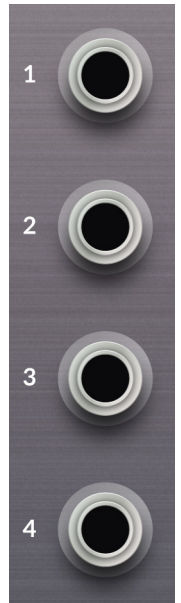

Power, Digital Clock Setup & Metering

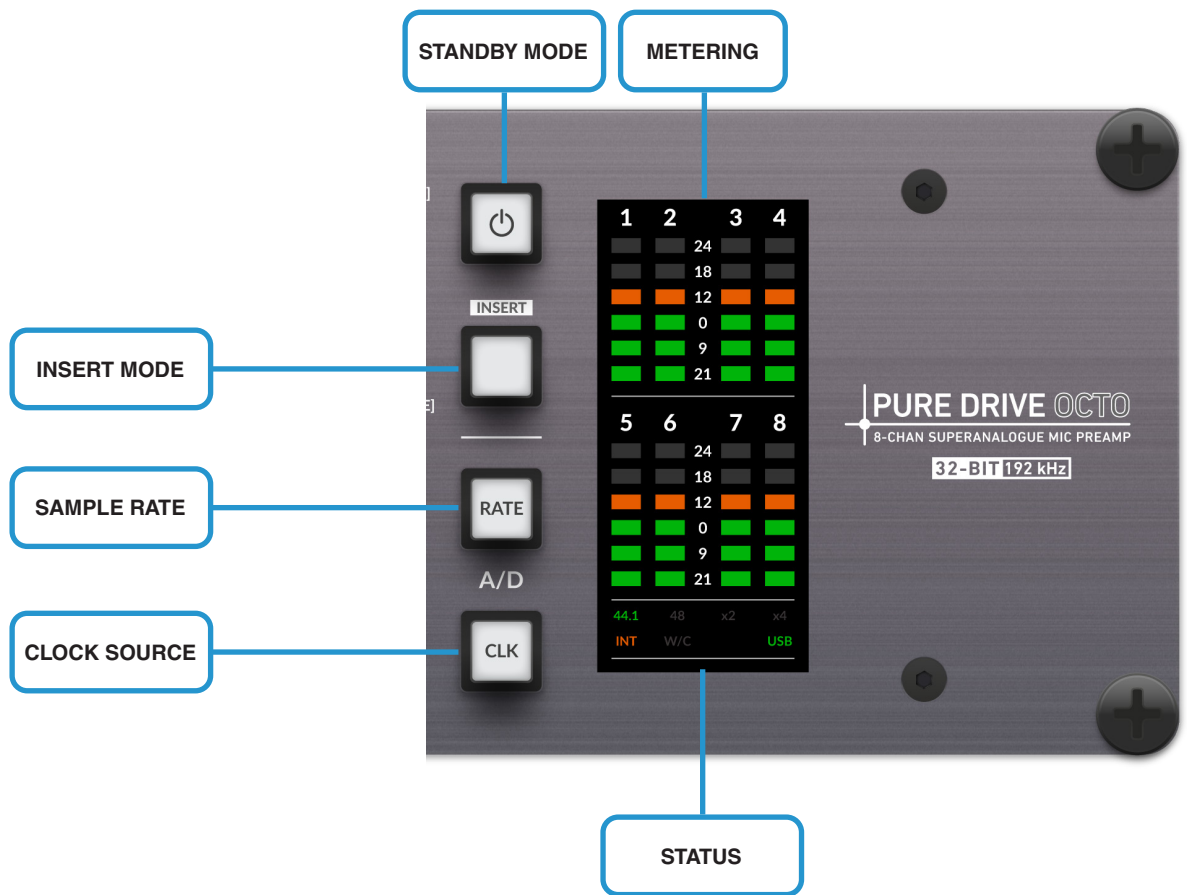

Metering

6-segment LED metering displays the signal level in dBu at the analogue to digital converter stage. The peak hold segment and the release ballistics can be adjusted to suit your preference. Please refer to the Settings section of this user guide for more information.

INSERT MODE

Engaging the **INSERT MODE** button hijacks the channel **ZΩ** buttons to become insert return enable/disable whilst the **INSERT MODE** button is engaged. The button will pulse bright white whilst active.

STANDBY MODE (SLEEP)

STANDBY MODE provides a convenient way of putting the unit to sleep from the front panel. To do this, press and hold the **STANDBY MODE** button for a second. All front panel buttons and LEDs will turn off, with the exception of the **STANDBY MODE** button itself, which will slowly pulse. **STANDBY MODE** puts the unit into a low power state, shutting down the audio circuitry until the unit is woken from sleep. Simply press the **STANDBY MODE** button again to wake the unit from sleep. **STANDBY MODE** can also be configured to come on automatically after a specified amount of time of inactivity. Please refer to the Settings section of the user guide for more information.



RATE

Press the **RATE** button to change the sample rate of the built-in analogue to digital converter. Press and hold the **RATE** button to go backwards through the sample rate options.



The current sample rate is indicated by the lighting of the **44.1** and **48** (kHz), in conjunction with **x2** and **x4** markings in the status area.

FRONT PANEL INDICATION	SAMPLE RATE (kHz)
44.1	44.1
48	48
44.1 + x2	88.2
48 + x2	96
44.1 + x4	176.4
48 + x4	192

CLOCK

Press the **CLK** button to change the clock source - choose from **INT** (internal) or **W/C** (wordclock). Press and hold the **CLK** button to go backwards through the clock source options



The current clock source is indicated by the lighting of the **INT** and **W/C** markings in the status area.



When clocking from wordclock, the front panel sample rate indication will flash to inform you the source is not present or at a usable rate.

USB

Illuminates solid green to indicate that the unit is successfully connected to the host computer via the USB.

*Please note that when the unit is connected via USB, the front panel **RATE** and **CLK** buttons become inactive.*

Use your host computer to make adjustments to the Sample Rate and Clock Source. For more information on the built-in USB audio interface, refer to the USB audio interface section of this user guide.

Important information - Clocking to Wordclock whilst using USB on Mac

If PURE DRIVE is connected to your host computer via USB and you want to clock to wordclock, you must first set the Internal Clock rate of PURE DRIVE to match the external clock rate, and *then* change the clock selection from internal to Wordclock In.

Remember, when you are connected via USB, clock source switching must be done from AudioMIDI setup on your Mac, as the **RATE** and **CLK** front panel buttons are disabled on PURE DRIVE.

If the internal clock rate of PURE DRIVE does not match the external clock rate when the clock source is changed to external, then it will show up with *No Valid Formats* in Audio MIDI Setup on your Mac. To recover from this state, you must switch back to Internal clock.

It is also important to note that if you want to change the sample rate of the external clock, you must first set PURE DRIVE back to Internal clock, change the external clock rate as desired, then change PURE DRIVE to match the new rate of the external clock, before finally switching PURE DRIVE back to Wordclock In.

Rear Panel Connections

Mic/Line Analogue Inputs

The rear panel Combo-XLRs provide access to the analogue microphone-level inputs (via the XLR or line-level inputs via TRS jack). Use the **LINE** switch (long press on the **TRIM** control) on the front panel to switch between the two options. Alternatively, use the dedicated Line Inputs available on the D-Sub (DB25) connector.

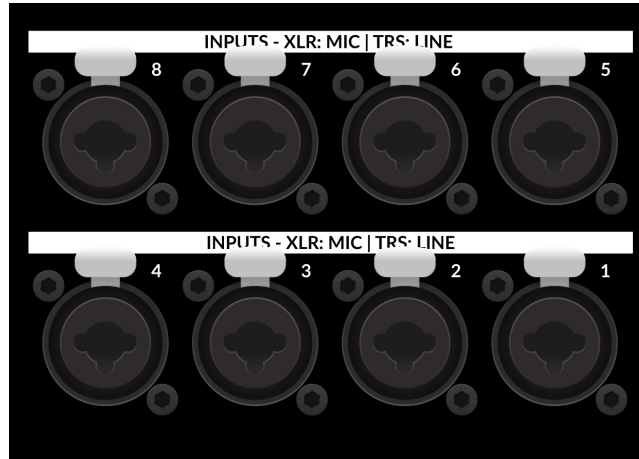

Analogue Outputs / Insert Sends

The rear panel D-Sub provide access to the balanced analogue outputs, which can also serve the purpose of acting as insert sends for connection to external processing devices.

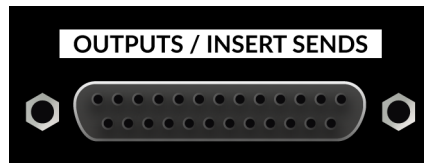

Line Inputs

The rear panel D-Sub connector provides access to the dedicated line-level inputs. You may find it more convenient to connect line inputs via this connector, to remove the need for unplugging/replugging the Combo-XLRs.

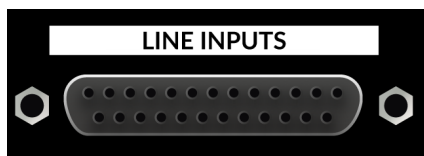

TRS and DB25 are hardwired in parallel. It is advisable to only use either/or and avoid using both simultaneously.

Insert Returns

The rear panel D-Sub connector provides access to the insert returns.

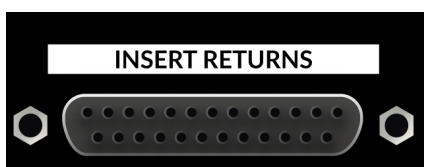

ADAT OUT

ADAT OUT - an optical ADAT outputs provides digital transmission of:

- 8 channels at 44.1/48 kHz, duplicated on both ports.
- 8 channels at 88.2/96 kHz (S/MUX), using one port for channels 1-4 and the other port for channels 5-8. Refer to square bracketed **[1-4]** and **[5-8]** text on the unit.
- 4 channels at 176.4/192 kHz (S/MUX), using one port for channels 1-2 (labelled **[1-4]**) and the other port for channels 3-4 (labelled **[5-8]**).

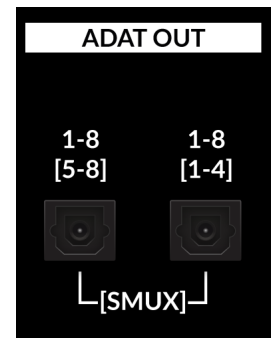

When using PURE DRIVE as a USB audio interface, the ADAT Outputs can be fed from the DAW as outputs (over USB) and provide a total of 16 channels of audio at 44.1/48 kHz using both ports. For more information on this, please refer to the '[Re-purposing the Digital Outputs as DAW Outputs](#)' section.

AES/EBU OUT

AES/EBU outputs are available as 1/2, 3/4, 5/6 and 7/8 pairs via the female XLR connectors. Please note that AES/EBU cable construction differs to that of standard XLR/microphone cables in order to guarantee certain impedance requirements. Please use AES/EBU specified cabling.



WORDCLOCK

Auto-ranging wordclock input and outputs are provided on BNC connectors. The **75Ω TERM** button provides a way of terminating the wordclock input. Engage this button if you are clocking PURE DRIVE via the wordclock input and it is the last device in the clocking chain.

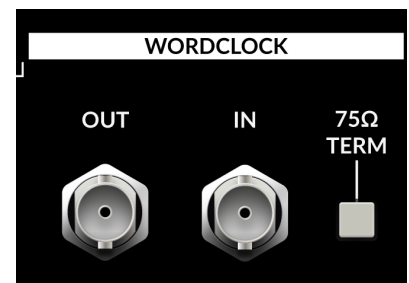

IEC Mains Inlet

PURE DRIVE uses an auto-ranging power supply. Simply connect the IEC to a mains power socket and use the rocker switch to power the unit on/off.

USB

USB 'C' type connector provides access to the built-in USB audio interface. Connect this to your host computer/DAW system.

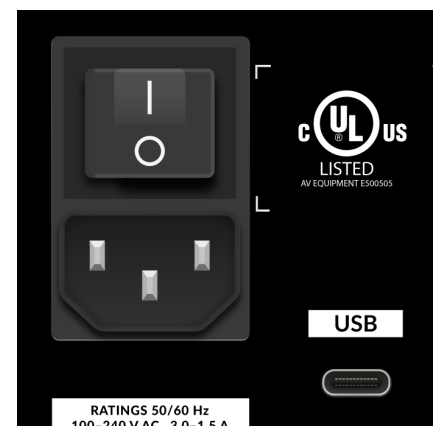

USB Audio Interface

A built-in USB audio interface provides a convenient way of recording PURE DRIVE's outputs directly into your DAW. Be aware that PURE DRIVE will present itself as an audio interface with 0 outputs, unless you configure the digital outputs to be sourced from your DAW's outputs using the Settings menu on the device.

Driver Installation

Mac OS - PURE DRIVE is class-compliant for Mac Core Audio - no driver installation required!

Windows - Install the SSL USB ASIO/WDM Audio Driver. Follow the steps below.

Step 1

Download and install the SSL USB ASIO/WDM Audio Driver from the SSL website (Downloads page). Once downloaded, open the SSL USB Control Panel application and select your PURE DRIVE device.

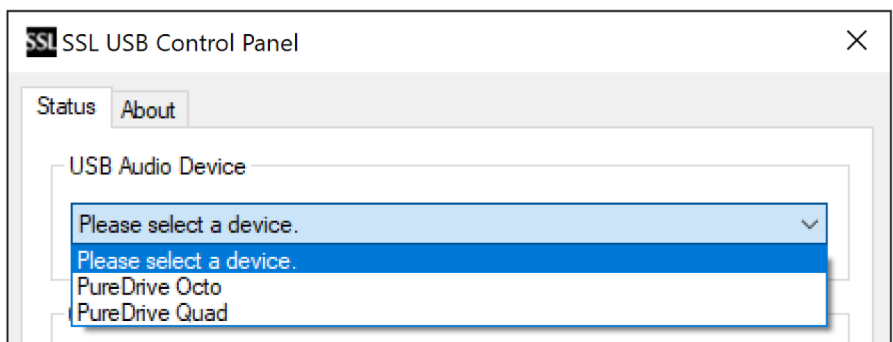

Step 2

With your device selected, go to the ASIO Device tab and link PURE DRIVE OCTO to one of the 4 available ASIO drivers e.g. SSL ASIO Driver 1.

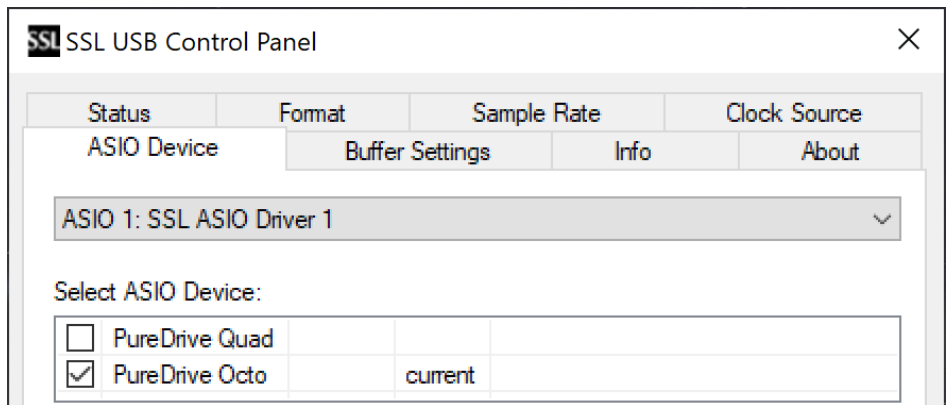

Step 3

In your DAW, choose the same SSL ASIO Driver as your audio interface. In this example, choose **SSL ASIO Driver 1**.

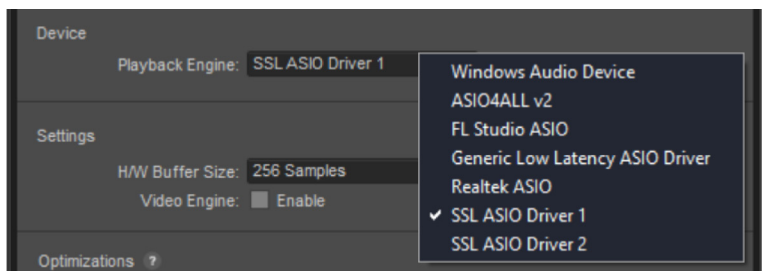

Aggregate Soundcard (Mac only)

PURE DRIVE does not feature a monitoring section for playback. As such, you may wish to consider using the Mac OS Aggregate Device feature in order to use PURE DRIVE alongside an existing audio interface that does. The example to the right shows SSL 2+ and PURE DRIVE OCTO being used together but this could be any audio interface. For more information on creating and using aggregate devices, please refer to the Mac OS documentation.

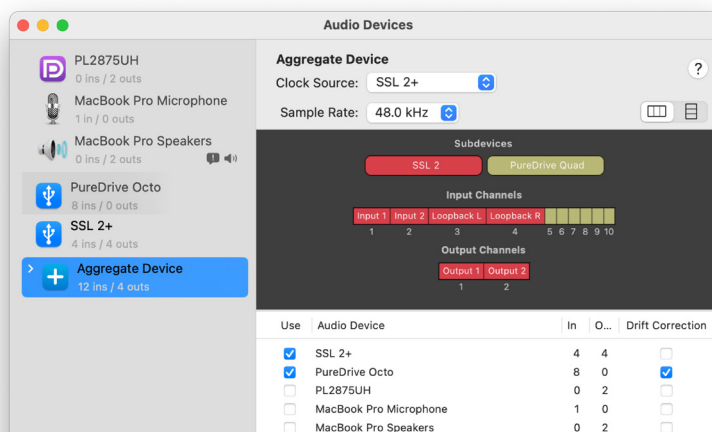

USB Audio Interface/DAW Inputs

8 inputs are available to the DAW at all sample rates up to and including 192 kHz.

SOURCE TYPE	SOURCE NAME	DAW Input (via USB)
ANALOGUE CHANNELS 1-8	Mic/Line/Inst Analogue In 1	1
	Mic/Line/Inst Analogue In 2	2
	Mic/Line/Inst Analogue In 3	3
	Mic/Line/Inst Analogue In 4	4
	Mic/Line Analogue In 5	5
	Mic/Line Analogue In 6	6
	Mic/Line Analogue In 7	7
	Mic/Line Analogue In 8	8

Re-purposing the Digital Outputs as DAW Outputs

Normally, the digital AES and ADAT outputs are fed from the Analogue to Digital converter. i.e. Analogue inputs are converted to ADAT and AES. However, it is possible to re-purpose the AES and ADAT outputs (independently) and feed them from the DAW (as outputs) via USB instead. Please refer to the Settings section of this user guide for the instructions on how to do this.

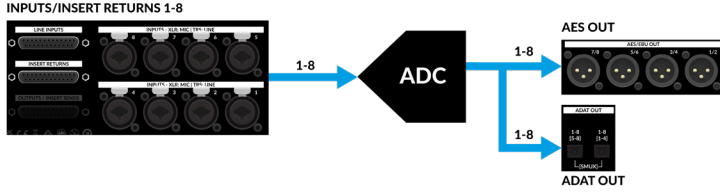

Normal mode - AES and ADAT Outputs fed from A-D converter

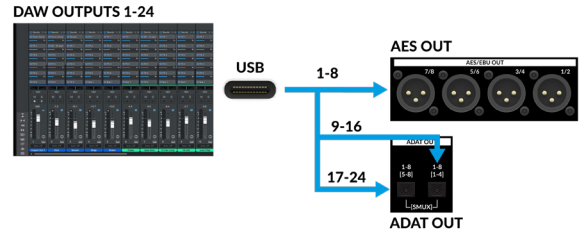

DAW feeds digital outputs mode - AES and ADAT fed from USB. Example given at 44.1/48 kHz

USB audio interface/DAW Outputs

The number of outputs available to the DAW depends on the sample rate you are working at. Also note that even if you configure the AES/EBU outputs to be fed from the ADC (default setting), if you have enabled the ADAT to be fed from USB the AES/EBU outputs will still show when connected to the computer, even though no signal is passed to them from USB. This is to keep the ordering of the output list consistent.

44.1/48 kHz

DAW Output (via USB)	PURE DRIVE	CONNECTOR
1/2	AES EBU Out 1/2	AES EBU XLR OUTPUTS
3/4	AES EBU Out 3/4	
5/6	AES EBU Out 5/6	
7/8	AES EBU Out 7/8	
9	ADAT Out 1	ADAT OUT 1-8 [1-4]
10	ADAT Out 2	
11	ADAT Out 3	
12	ADAT Out 4	
13	ADAT Out 5	
14	ADAT Out 6	
15	ADAT Out 7	
16	ADAT Out 8	
17	ADAT Out 9	ADAT OUT 1-8 [5-8]
18	ADAT Out 10	
19	ADAT Out 11	
20	ADAT Out 12	
21	ADAT Out 13	
22	ADAT Out 14	
23	ADAT Out 15	
24	ADAT Out 16	

88.2/96 kHz

DAW Output (via USB)	PURE DRIVE	CONNECTOR
1/2	AES EBU Out 1/2	AES EBU XLR OUTPUTS
3/4	AES EBU Out 3/4	
5/6	AES EBU Out 5/6	
7/8	AES EBU Out 7/8	
9	ADAT Out 1	ADAT OUT 1-8 [1-4]
10	ADAT Out 2	
11	ADAT Out 3	
12	ADAT Out 4	
13	ADAT Out 5	ADAT OUT 1-8 [5-8]
14	ADAT Out 6	
15	ADAT Out 7	
16	ADAT Out 8	

176.4/192 kHz

DAW Output (via USB)	PURE DRIVE	CONNECTOR
1/2	AES EBU Out 1/2	AES EBU XLR OUTPUTS
3/4	AES EBU Out 3/4	
5/6	AES EBU Out 5/6	
7/8	AES EBU Out 7/8	
9	ADAT Out 1	ADAT OUT 1-8 [1-4]
10	ADAT Out 2	
11	ADAT Out 3	
12	ADAT Out 4	ADAT OUT 1-8 [5-8]

Firmware Updates

From time to time, there may be firmware updates available via the SSL USB Audio Firmware Updater application (Mac/Windows). Such updates will be documented on the [SSL Support site](#).

It is recommended to avoid using a USB hub and instead use a direct USB connection between PURE DRIVE and your computer when performing firmware updates.

Settings

There are a number of configurable settings available for PURE DRIVE OCTO.

To access these, hold down the **CLK** button whilst the unit is powering on.

Read through the information on the following pages to understand which switches affect which particular setting.

When you are finished adjusting settings, press and hold **STANDBY** button and the unit will power cycle back into the normal operating mode.



Enter Settings mode

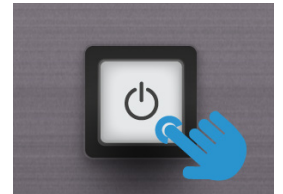

Exit Settings mode

Settings Layout - Overview Map

Below is a quick way of identifying which controls/buttons affect each setting, at a glance.

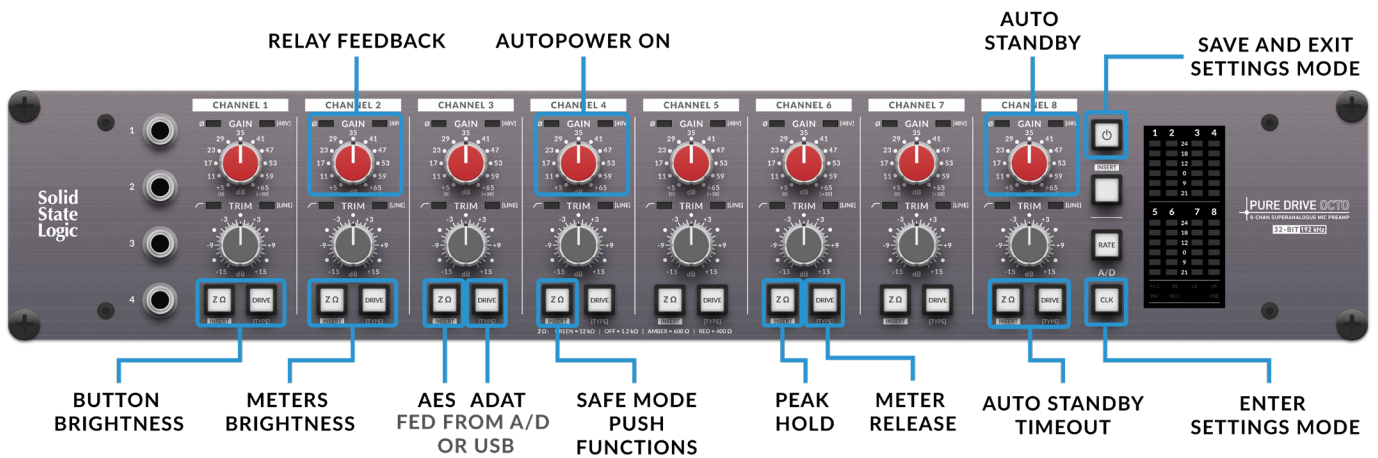

Button Brightness

8 levels of brightness are available for the button lights. Factory setting: Level 5 of 8.

1. Enter Settings mode by holding the **CLK** button whilst powering the unit on.
2. Use Channel 1 **ZΩ** and **DRIVE** buttons to decrease/increase the brightness.
3. Save your settings and Exit Settings mode by holding the **STANDBY** button until the unit power cycles back into normal operation. Alternatively, continue to make adjustments to other settings before actioning this step.



*Channel 1 Buttons
+ZΩ decreases brightness,
DRIVE increases brightness*

Meters Brightness

8 levels of brightness are available for the meters. Factory setting: Level 8 of 8.

1. Enter Settings mode by holding the **CLK** button whilst powering the unit on.
2. Use Channel 2 **ZΩ** and **DRIVE** buttons to decrease/increase the brightness.
3. Save your settings and Exit Settings mode by holding the **STANDBY** button until the unit power cycles back into normal operation. Alternatively, continue to make adjustments to other settings before actioning this step.

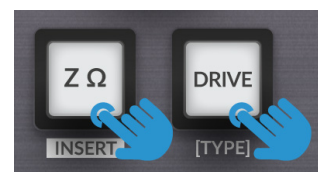

*Channel 2 Buttons
+ZΩ decreases brightness,
DRIVE increases brightness*

Relay Feedback

You can enable/disable the button relay feedback (audible click when a button is pressed). This affects the startup sequence and normal operation. To toggle between enabled and disabled:

1. Enter Settings mode by holding the **CLK** button whilst powering the unit on.
2. Press the Channel 2 **GAIN** control. If the **[48V]** LED is lit, relay feedback is enabled (default). If the **[48V]** LED is off, relay feedback is disabled.
3. Save your settings and Exit Settings mode by holding the **STANDBY** button until the unit power cycles back into normal operation. Alternatively, continue to make adjustments to other settings before actioning this step.



*Channel 2 GAIN
Relay enabled*

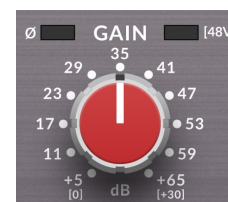

*Channel 2 GAIN
Relay disabled*

Autopower On Enable

Autopower On is a parameter that defines if the unit should automatically boot when power is applied, or just stay in Standby mode. Default setting is enabled. To toggle between enabled and disabled:

1. Enter Settings mode by holding the **CLK** button whilst powering the unit on.
2. Press the Channel 4 **GAIN** control. If the **[48V]** LED is lit, Autopower On is enabled. If the **[48V]** LED is off, Autopower On is disabled.
3. Save your settings and Exit Settings mode by holding the **STANDBY** button until the unit power cycles back into normal operation. Alternatively, continue to make adjustments to other settings before actioning this step.



Channel 4 GAIN
Autopower On
enabled



Channel 4 GAIN
Autopower On
disabled

Auto Standby (Sleep) Mode Enable

In addition to putting PURE DRIVE into Standby Mode (Sleep) manually from the front panel, the unit can enter it automatically after a specified amount of time of inactivity. Inactivity can mean either the pots and/or switches have not been operated. It can also mean there has been no audio present above 0 dBu. By default Auto Standby Mode is disabled. To toggle between enabled and disabled:

1. Enter Settings mode by holding the **CLK** button whilst powering the unit on.
2. Press the Channel 8 **GAIN** control. If the **[48V]** LED is lit, Auto Standby Mode is enabled. If the **[48V]** LED is off, Auto Standby Mode is disabled (default).
3. Save your settings and Exit Settings mode by holding the **STANDBY** button until the unit power cycles back into normal operation. Alternatively, continue to make adjustments to other settings before actioning this step.



Channel 8 GAIN
Auto Standby
enabled



Channel 8 GAIN
Auto Standby
disabled

Auto Standby (Sleep) Timeout

If you have enabled Auto Standby Mode, you can adjust the timeout (amount of time before it automatically engages Standby Mode) by using the Channel 8 **ZΩ** and **DRIVE** buttons to decrease/increase the timeout time. The default settings is 20 minutes.

1. Enter Settings mode by holding the **CLK** button whilst powering the unit on.
2. Ensure Auto Standby Mode Enable is enabled (see previous setting explanation).
3. Use Channel 8 **ZΩ** and **DRIVE** buttons to decrease/increase the Auto Standby timeout.
4. Save your settings and Exit Settings mode by holding the **STANDBY** button until the unit power cycles back into normal operation. Alternatively, continue to make adjustments to other settings before actioning this step..

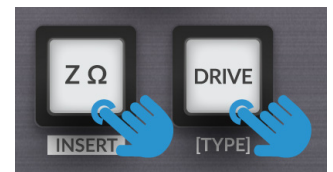

Channel 8 Buttons
ZΩ decreases timeout,
DRIVE increases timeout

The current timeout setting is displayed on the bottom 4 segments of the meter in a binary fashion. LSB is leftmost, MSB is rightmost. The binary number multiplied by 5 minutes gives the total timeout time. See the next page for a table detailing the options.

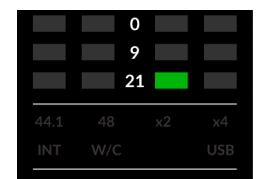

Bottom row of meter LEDs
indicate timeout setting

Auto Standby Timeout Table

1st LED	2nd LED	3rd LED	4th LED	Timeout
0	0	0	0	15 seconds
1	0	0	0	5 min
0	1	0	0	10 min
1	1	0	0	15 min
0	0	1	0	20 min (default)
1	0	1	0	25 min
0	1	1	0	30 min
1	1	1	0	35 min
0	0	0	1	40 min
1	0	0	1	45 min
0	1	0	1	50 min
1	1	0	1	55 min
0	0	1	1	60 min
1	0	1	1	65 min
0	1	1	1	70 min
1	1	1	1	75 min

Re-purposing the Digital Outputs as DAW Outputs

By default, AES and ADAT outputs are fed by signal coming from the Analogue to Digital Converters - i.e. Analogue inputs are converted to ADAT and AES. Optionally, it is possible to select audio from the DAW (outputs) via USB as source - i.e re-purpose the AES and ADAT outputs (independently) and instead feed them from the DAW (as outputs) via USB.

1. Enter Settings mode by holding the **CLK** button whilst powering the unit on.
2. Use Channel 3 **ZΩ** button to toggle between ADC or USB for the AES outputs.
3. Use Channel 3 **DRIVE** button to toggle between ADC or USB for the ADAT outputs.
4. Save your settings and Exit Settings mode by holding the **STANDBY** button until the unit power cycles back into normal operation. Alternatively, continue to make adjustments to other settings before actioning this step..



Channel 3 Buttons

ZΩ: AES - ADC or USB

DRIVE: ADAT - ADC or USB

AES Outputs

Channel 3 **ZΩ** Button Colour: **Red** = internal ADC source (default)

Channel 3 **ZΩ** Button Colour: **Green** = DAW USB source

ADAT Output

Channel 3 **DRIVE** Button Colour: Dim White = internal ADC source (default)

Channel 3 **DRIVE** Button Colour: **Red**: DAW USB source

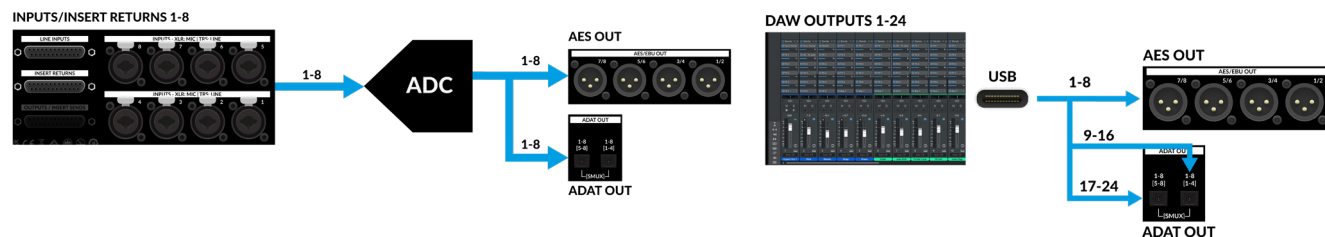

Normal mode - AES and ADAT Outputs fed from A-D converter

DAW feeds digital outputs mode - AES and ADAT fed from USB. Example given at 44.1/48 kHz

Safe Mode for Ø, +48V, HPF and LINE Push Functions

The **Ø** (Polarity Flip), **+48V**, **HPF** and **LINE** functions are toggled by short or long pushes on the **GAIN** and **TRIM** controls. In some critical environments situations, engineers may prefer to reduce the risk of accidentally pushing these functions as they have the ability to disrupt the or alter the audio unintentionally. Therefore, Safe Mode increases the amount of time the control has to be pushed in order for the function to be toggled on or off.

1. Enter Settings mode by holding the **CLK** button whilst powering the unit on.
2. Use Channel 4 **ZΩ** button to turn safe mode on/off. Dim white = normal operation. Red = Safe Mode on.
3. Save your settings and Exit Settings mode by holding the **STANDBY** button until the unit power cycles back into normal operation. Alternatively, continue to make adjustments to other settings before actioning this step.



Channel 4
ZΩ toggles
safe mode on/off

Peak Hold

You can adjust the peak hold meter segment to suit your preference.

1. Enter Settings mode by holding the **CLK** button whilst powering the unit on.
2. Use Channel 6 **ZΩ** button to choose your preferred peak hold setting (see list below).
3. Save your settings and Exit Settings mode by holding the **STANDBY** button until the unit power cycles back into normal operation. Alternatively, continue to make adjustments to other settings before actioning this step.

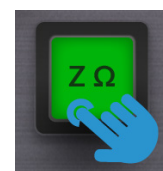

Channel 6
ZΩ toggles
Peak Hold

Channel 6 ZΩ button:

Dim white: OFF

Green: 1 second

Orange: 3 seconds (default)

Red: 10 seconds

Meter Release

You can adjust the meter release time (ballistics) to suit your preference.

1. Enter Settings mode by holding the **CLK** button whilst powering the unit on.
2. Use Channel 6 **DRIVE** button to choose your preferred meter release setting (see list below).
3. Save your settings and Exit Settings mode by holding the **STANDBY** button until the unit power cycles back into normal operation. Alternatively, continue to make adjustments to other settings before actioning this step.

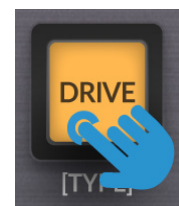

Channel 6
DRIVE toggles
Meter Release

Channel 6 DRIVE button:

Green: Slow

Orange: Standard (default)

Red: Fast

Factory Reset

To return the unit to the factory-shipped state, you can perform a factory reset by following these instructions:

- During unit power up, press and hold both the Channel 1 **ZΩ** button and Channel 8 **DRIVE** buttons until all the **DRIVE** buttons flash red.
- Release the held buttons and the unit will reboot automatically with factory settings restored.



Press and hold both Channel 1 ZΩ and Channel 8 DRIVE buttons during boot to trigger a factory reset.

Settings affected by Factory Reset:

- Switch states
- Shaft switch states
- Buttons Brightness (default: 5th level of 8)
- Meters Brightness (default: 8th level of 8)
- Relay feedback (default: ON)
- Autopower on (default: enabled)
- Auto Standby Mode (default: disabled)
- Auto Standby Mode timeout (default: 20 min)

Troubleshooting

UID Display

UID Display Mode displays the UID number of the firmware currently in use and the hardware revision of both main card and front panel card. To enter UID Display Mode, press and hold the **RATE** button during the power-up sequence.



Number of digits for each item:

- Firmware UID: 5 digit number
- Mainboard HW revision: 1 digit number
- Frontpanel HW revision: 1 digit number

Digits are displayed individually on the meters in binary. Each digit is shown per row of meter LEDs:

From the top:

1st row to 5th row: Firmware UID 1st to 5th digit

From the bottom:

1st row: Mainboard HW revision digit

2nd row: Frontpanel HW revision digit

Unlit means “0”, lit means “1”. See table:

1st LED	2nd LED	3rd LED	4th LED	Digit
0	0	0	0	0
0	0	0	1	1
0	0	1	0	2
0	0	1	1	3
0	1	0	0	4
0	1	0	1	5
0	1	1	0	6
0	1	1	1	7
1	0	0	0	8
1	0	0	1	9

Exit UID Display mode by holding the **STANDBY** button until the unit power cycles back into normal operation.

Unsure how to read the information? Take a photo and a Support engineer will help you.

Soak and Potentiometer Test Mode

Soak mode is used to check the correct operation of all lights and indicators on front panel. It cycles through the phases listed below. To enter Soak mode, hold down Channel 1 **ZΩ** and **DRIVE** buttons during the power-up sequence.

1. All switches lights bright white, if available (otherwise off) + meters pattern
2. All switches lights red, if available (otherwise dim white) + meters pattern
3. All switches lights green, if available (otherwise dim white) + meters pattern
4. All indicators lit up (green or red, depending on function) + meters pattern
5. Same as 1 but meters full lit
6. Same as 2 but meters full lit
7. Same as 3 but meters full lit
8. Same as 4 but meters full lit



In this mode it's also possible to test the correct operation of the potentiometers. A position change on any of the pots will trigger the relay to click as a confirmation feedback.

Channel 1 **GAIN** controls the speed at which the patterns are cycled.

Full CCW position pauses the animation at the current step. Rotating the knob towards clockwise direction will increase pattern speed.

Exit Soak and Potentiometer Test Mode mode by holding the **STANDBY** button until the unit power cycles back into normal operation.

Specifications

Default test conditions (unless otherwise stated):

Source impedance of test set: 40Ω

Input impedance of test set: 100 kΩ

Reference frequency: 1 kHz

Reference level: 0 dBu

All unweighted measurements are specified as 20 Hz to 20 kHz bandwidth limited, expressed in dBu.

Onset of clipping (for headroom measurements) should be taken as 1% THD.

All levels are intended balanced, unless explicitly defined otherwise.

ADC sample rate 48 kHz

HPF disabled/set to minimum

TRIM set to center position (0 dB)

Gain set to minimum

Z set to highest (green)

DRIVE disabled

Unless otherwise quoted all figures have a tolerance of ±0.5dB or 5%.

Unit General

Power

Power Supply	Auto-Ranging 100-240 VAC
Operating Power	< 45 Watts
Standby Mode	< 6.9 Watts

Physical

Width	482.6 mm / 19 inches
Height	88.1 mm / 3.5 inches (2 RU)
Depth	302.8 mm / 11.9 inches (chassis only) 338.4 mm / 13.3 inches (including front panel controls and rear panel connections)
Weight	6.2 kg / 13.7 lbs
Boxed Dimensions	550mm x 470mm x 210mm (21.7" x 18.5" x 8.3")

Connectors

Inputs	Combo XLR x4
Outputs/Insert Sends	Male XLR x4
Insert Returns & Line Inputs	25-way D-type Female (D-Sub) x1
AES/EBU Outputs	Male XLR x2
ADAT Output and ADAT Link In	Optical TOSLINK Port x2
Wordclock Input and Output	BNC connector x 2
USB	'C' Type USB Port x1

Mic In to Insert Send

Measurement	Value	Conditions
Input Impedance	12 k Ω	Green setting
	1.2 k Ω	Dim White setting
	600 Ω	Orange setting
	400 Ω	Red setting
Output Impedance	70 Ω	-
Gain	4.8 dB typical \pm 0.1dB	5 dB gain
	11.3 dB typical \pm 0.1dB	11 dB gain
	16.6 dB typical \pm 0.1dB	17 dB gain
	22.9 dB typical \pm 0.1dB	23 dB gain
	28.9 dB typical \pm 0.1dB	29 dB gain
	35.3 dB typical \pm 0.1dB	35 dB gain
	41.6 dB typical \pm 0.1dB	41 dB gain
	47.5 dB typical \pm 0.1dB	47 dB gain
	53.3 dB typical \pm 0.1dB	53 dB gain
	59.2 dB typical \pm 0.1dB	59 dB gain
65.5 dB typical \pm 0.1dB	65 dB gain	
Gain Matching	< 0.08 dB	Any gain setting
Noise Floor (Unweighted)	< -97.3 dBu	17 dB gain, unweighted, 20 Hz - 20kHz, 150R termination
EIN	-130.0 dBu typical, -129.0 dBu nominal	65 dB gain, A-weighted, 20 Hz - 20kHz, 150R termination
Frequency Response	\pm 0.2 dB	20 to 20 kHz, any gain
THD+N Ratio	< -92 dB / 0.0025%	17 dB gain, 20 dBu out, 1 kHz
Crosstalk	< -108 dB	Aggressor 15 dBu 50 Hz in, 5 dB gain, 20 dBu out Adjacent channels 150R terminator, 35 dB gain
	< -105 dB	Aggressor 15 dBu 1 kHz in, 5 dB gain, 20 dBu out Adjacent channels 150R terminator, 35 dB gain
	< -81 dB	Aggressor 15 dBu 10 kHz in, 5 dB gain, 20 dBu out Adjacent channels 150R terminator, 35 dB gain
Maximum Input Level	> 21.5 dBu	Minimum gain

Line In to Insert Send

Measurement	Value	Conditions
Input Impedance	22 kΩ	-
Gain	-0.4 dB typical ±0.1dB	0 dB gain
	3.0 dB typical ±0.1dB	3 dB gain
	6.1 dB typical ±0.1dB	6 dB gain
	8.7 dB typical ±0.1dB	9 dB gain
	11.4 dB typical ±0.1dB	12 dB gain
	14.8 dB typical ±0.1dB	15 dB gain
	17.7 dB typical ±0.1dB	18 dB gain
	20.7 dB typical ±0.1dB	21 dB gain
	23.6 dB typical ±0.1dB	24 dB gain
	27.4 dB typical ±0.1dB	27 dB gain
30.0 dB typical ±0.1dB	30 dB gain	
Gain Matching	< 0.08 dB	Any gain setting
Noise Floor (Unweighted)	-89.7dBu typical	0 dB gain, unweighted, 20 Hz - 20kHz, 150R termination
THD+N Ratio	-89.6 dB / 0.0033% typical	0 dB gain, 0 dBu out, 1 kHz
Maximum Input Level	26.5 dBu	Minimum gain

Hi-Z to Insert Send

Measurement	Value	Conditions
Input Impedance	1 MΩ (unbalanced)	-
Gain	10.9 dB typical ±0.1dB	11 dB gain
	14.3 dB typical ±0.1dB	14 dB gain
	17.4 dB typical ±0.1dB	17 dB gain
	20.0 dB typical ±0.1dB	20 dB gain
	22.7 dB typical ±0.1dB	23 dB gain
	26.1 dB typical ±0.1dB	26 dB gain
	29.0 dB typical ±0.1dB	29 dB gain
	32.1 dB typical ±0.1dB	32 dB gain
	34.9 dB typical ±0.1dB	35 dB gain
	38.7 dB typical ±0.1dB	38 dB gain
41.3 dB typical ±0.1dB	41 dB gain	
Gain Matching	< 0.08 dB	Any gain setting
Noise Floor (Unweighted)	< 86 dBu typical	11 dB gain, unweighted, 20 Hz - 20kHz, 150R termination
Maximum Input Level	> 15.5 dBu (unbalanced)	Minimum gain

Insert Return to ADC

Measurement	Value	Conditions
Input Impedance	10 k Ω	-
ADC Line-Up	24.0 dBu	-
Frequency Response	± 0.035 dB -3 dB low roll-off < 5 Hz	Linearity, any sample rate -3 dB roll-off, any sample rate
THD+N Ratio	-105 dB / 0.0005% typical	20 dBu, 1 kHz
Dynamic Range	119 dB typical	20 Hz to 20 kHz, A-weighted
Crosstalk	< 105 dB	23.9 dBu in, 20 Hz to 20 kHz, 1 channel driven, all other channels 150R terminated
	< -115 dB	23.9 dBu in, 1 kHz, 1 channel driven, all other channels 150R terminated

Trim & High-Pass Filter (HPF)

Measurement	Value	Conditions
Trim Gain Matching	< 0.04 dB	Any gain setting
HPF Frequency Tolerance	5%	Any HPF setting

Block Diagram

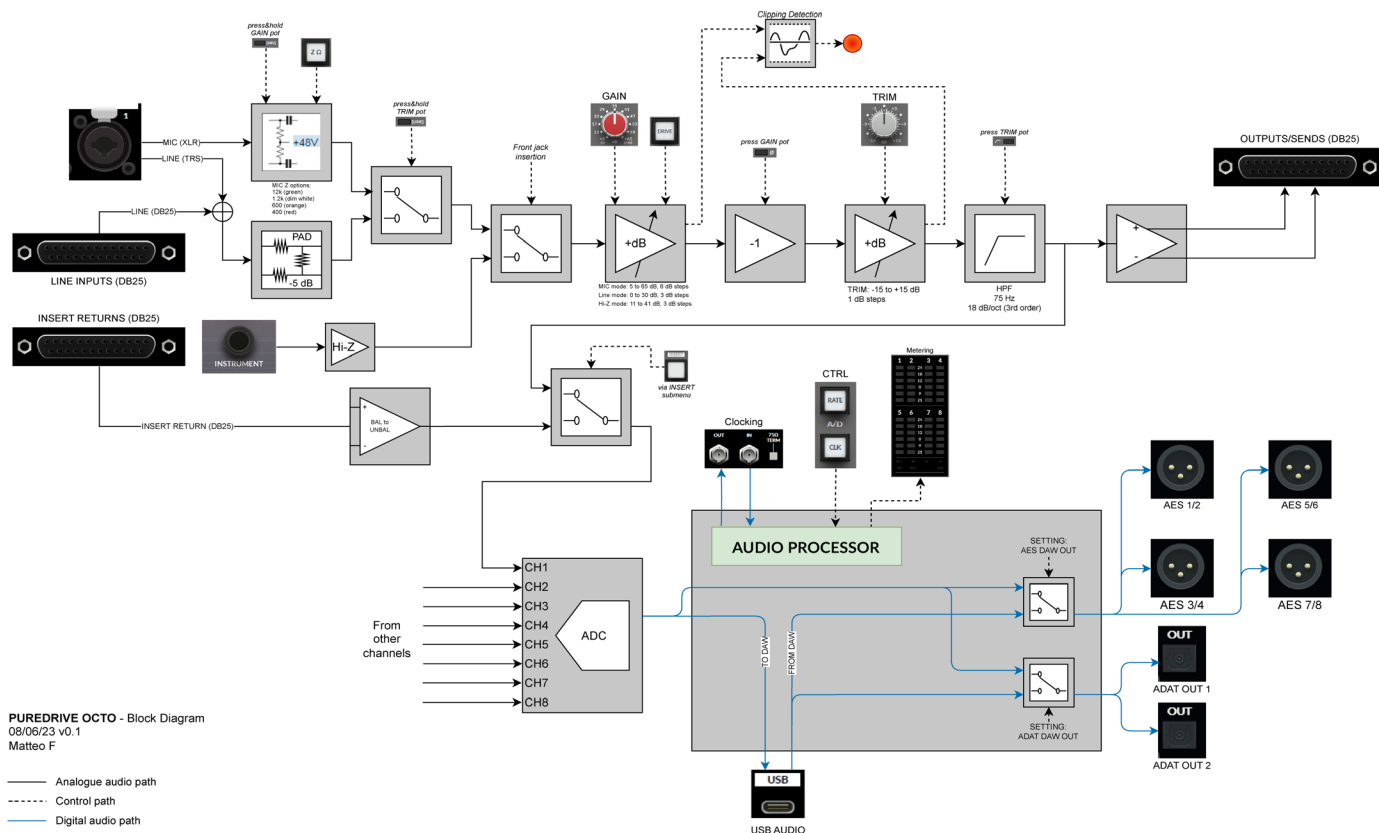

Safety Notices

General Safety

- Please read and keep this document and adhere to all warnings and instructions.
- This electrical equipment should not be exposed to dust, water, or other liquids.
- Clean only with dry cloth or products compatible with electrical devices and never when the unit is powered.
- Do not operate near any heat sources, in direct sunlight or near naked flames.
- Do not place heavy objects on the unit.
- Only use attachments/accessories recommended by the manufacturer.
- Unplug this apparatus during lightning storms or when unused for long periods of time.
- Do NOT modify this unit, alterations may affect performance, safety and/or international compliance standards.
- The unit can only be serviced by qualified personnel – seek immediate service if the console has been exposed to water or if it ceases to operate normally.
- SSL does not accept liability for damage caused by maintenance, repair or modification by unauthorised personnel.
- When using this apparatus either fix it into a standard 19" rack or place it on a secure level surface.
- If the unit is rack mounted, fit all rack screws. Rack shelves are recommended.
- Do not block any ventilation openings. Install in accordance with the manufacturer's instructions.
- Always allow free flow of air around the unit for cooling.
- Ensure that no strain is placed on any cables connected to this apparatus. Ensure that all such cables are not placed where they can be stepped on, pulled or tripped over.

Power Safety

- This equipment is supplied with mains lead however if you wish to use a mains cables of your choice refer to the following information:
- Refer to the rating label on rear of the unit and always use a suitable mains cord.
- The unit should ALWAYS be earthed.
- Please use-compliant 60320 C13 TYPE SOCKET. When connecting to supply outlets ensure that appropriate sized conductors and plugs are used to suit local electrical requirements.
- Maximum cord length should be 4.5m(15').
- The cord should bear the approval mark of the country in which it is to be used.

Additionally:

- The appliance coupler is used as the disconnect device, ensure that it is connected to an unobstructed wall outlet.
- Connect only to an AC power source that contains a protective earthing (PE) conductor.
- Only connect units to single phase supplies with the neutral conductor at earth potential.



ATTENTION! This product must always be earthed.

CAUTION! No user-serviceable parts inside. In the event of damage to the unit contact Solid State Logic. Service or repair must be done by qualified service personnel only.



This product complies with the following United Kingdom Legislation:

UK Electrical Equipment (Safety) Regulations 2016 (SI 2016/1101)

UK Electromagnetic Compatibility Regulations 2016 (SI 2016/1091).

The Eco-design requirements for Energy related products (ErP) 2009/125/EC.

The Restriction of the use of certain Hazardous Substances in Electrical and Electronic Equipment (RoHS2) Regulations 2012 (SI 2012/3032).



This product complies with the following European Union Harmonisation Legislation:

EU Low Voltage directive (LVD) 2014/35/EU,

EU Electromagnetic Compatibility directive (EMC) 2014/30/EU.

The Eco-design requirements for Energy related products (ErP) 2009/125/EC.

The Restriction of the use of certain Hazardous Substances in Electrical and Electronic Equipment Directive (RoHS2) 2011/65/EU.

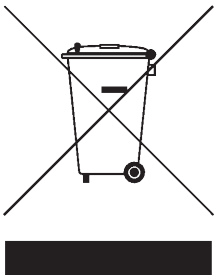

Instructions for disposal of WEEE by users in the European Union

The symbol shown here, which is on the product or on its packaging, indicates that this product must not be disposed of with other waste. Instead, it is the user's responsibility to dispose of their waste equipment by handing it over to a designated collection point for recycling of waste electrical and electronic equipment. The separate collection and recycling of your waste equipment at the time of disposal will help to conserve natural resources and ensure that it is recycled in a manner that protects human health and the environment. For more information about where you can drop off your waste equipment for recycling, please contact your local city office, your household waste disposal service or where you purchased the product.

FCC Certification

- This device complies with part 15 of the FCC Rules. Operation is subject to the following two conditions: (1) This device may not cause harmful interference, and (2) this device must accept any interference received, including interference that may cause undesired operation.

For the user:

- Do not modify this unit! This product, when installed as indicated in the instructions contained in the installation manual, meets FCC requirements.
- Important: This product satisfies FCC regulations when high quality shielded cables are used to connect with other equipment. Failure to use high quality shielded cables or to follow the installation instructions may cause electromagnetic interference with appliances such as radios and televisions and will void your FCC authorisation to use this product in the USA.
- This equipment has been tested and found to comply with the limits for a Class A digital device, pursuant to part 15 of the FCC Rules. These limits are designed to provide reasonable protection against harmful interference when the equipment is operated in a commercial environment. This equipment generates, uses, and can radiate radio frequency energy and, if not installed and used in accordance with the instruction manual, may cause harmful interference to radio communications. Operation of this equipment in a residential area is likely to cause harmful interference in which case the user will be required to correct the interference at his own expense.

Industry Canada Compliance

This Class A digital apparatus complies with Canadian ICES-003.

Cet appareil numérique de la classe A est conforme à la norme NMB-003 du Canada.

Electromagnetic Compatibility

BS EN 55032:2015, Class A. BS EN 55035:2017.

WARNING: The audio input/output ports are screened cable ports and any connections to them should be made using braid-screened cable and metal connector shells to provide a low impedance connection between the cable screen and the device.

Electrical Safety

IEC 62368-1:2018

BS EN IEC 62368-1:2020+A11:2020

CSA CAN/CSA-C22.2 No. 62368-1 3rd Ed.

UL 62368-1 3rd Ed.



WARNING: Cancer and Reproductive Harm - www.P65Warnings.ca.gov

Environmental

Temperature: Operating: +1 to 30 degrees Celsius. Storage: -20 to 50 degrees Celsius.

Further information

For additional information, product downloads, knowledge base and technical support visit the www.solidstatelogic.com.

